



PERCOTRONICS®



TP TESTER

@percotronics



www.percotronics.com

TP TESTER



Equipment designed for testing and calibrating **EURO III • EURO IV dosing (M) and timing (T) actuators.**

MAIN FUNCTIONS:

- Dynamic flow measurement **using high-precision flow meters.**
- **Automatic feed pressure** adjustment.
- **User-friendly software** with automatic test routines.
- Built-in database.
- **Test reports.**

FUNCIONAMIENTO SIMPLE Y DINÁMICO:

Equipment designed for testing and calibrating **dosing (M) and timing (T) actuators.**

- Insulation test.
- Stroke/electrical test.
- Static leakage test.
- Dynamic leakage test.
- Flow test under 2 different conditions.



TP TESTER

INCLUYE HERRAMIENTAS PARA ACTUADORES TP

- Disassembly
- Evaluation
- Recovery
- Reassembly

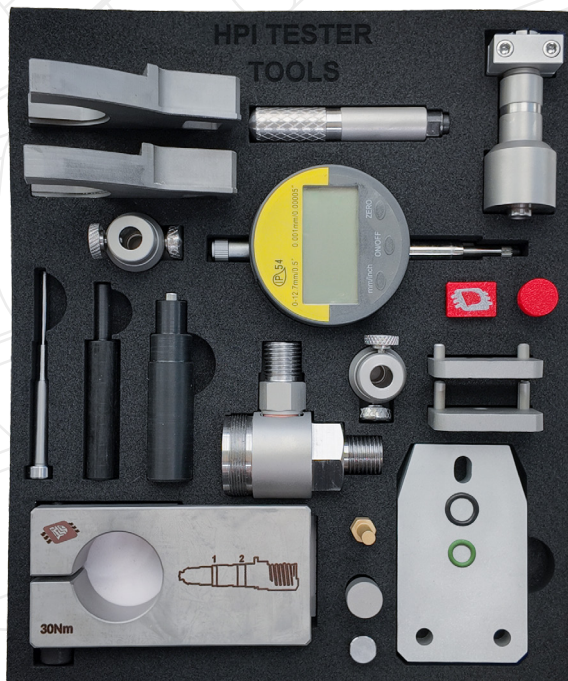

N.º de Elemento	Descripción
1	HPI-TP Control Module
2	Main TP TESTER Wiring Harness
3	Actuator Wiring Harness
4	TP Actuator Measurement and Regulation Assembly

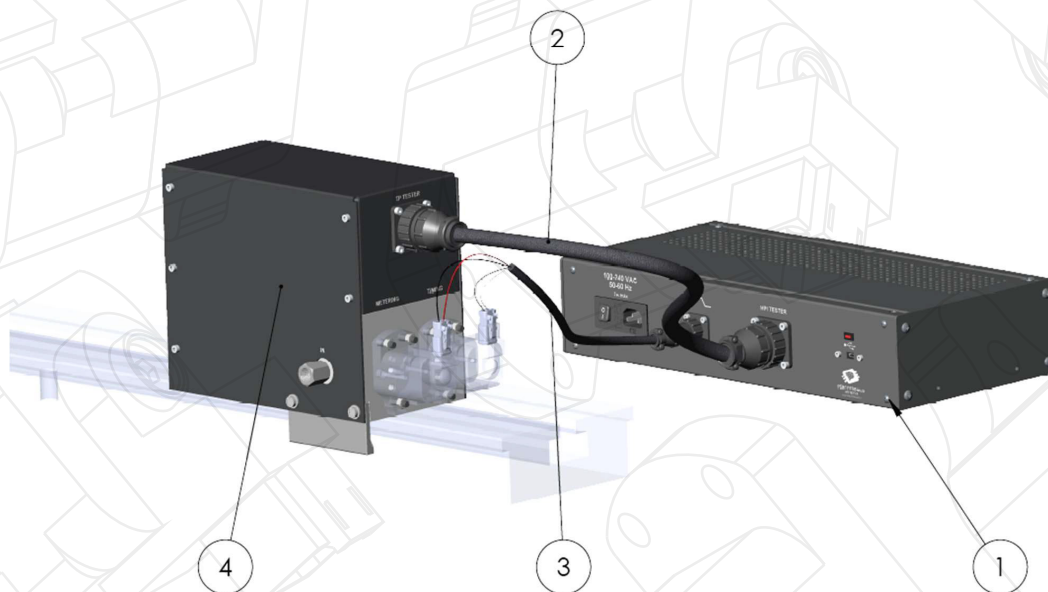

SOFTWARE TP TESTER

CON EXPERIENCIA DE USUARIO INTUITIVA

Evaluation Parameters



TP TESTER
EURO III

Voltaje **12,5** V
RPM **1000** 1/min
Presión **20,0** bar
Temp **31,8** °C
Retorno **5689,1** ml
Conteo **14** seg

Testing

INICIO

METERING

Metering

Aislamiento

Eléctrica

Fuga

Contribución 1

Contribución 2

TIMING

Timing

Aislamiento

Eléctrica

Fuga

Contribución 1

Contribución 2

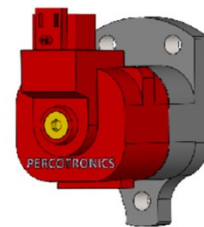

REPORTES CLIENTE

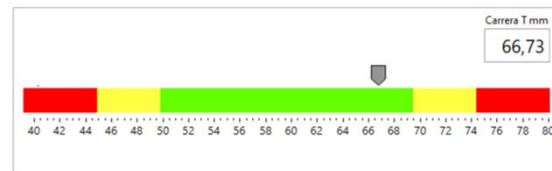
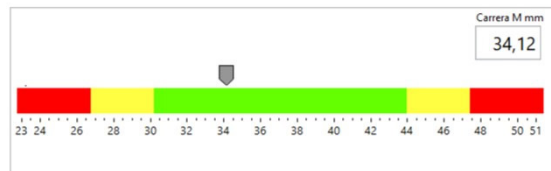
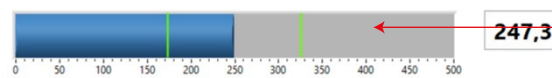
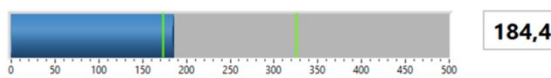

Closing Time Measurement

Flow Delivery

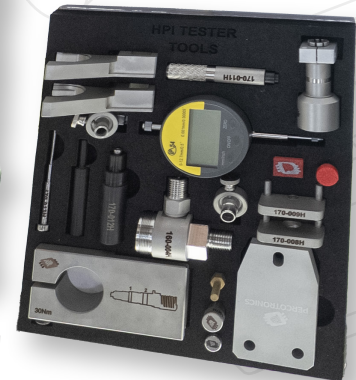

INCLUDES:

- Interface
- Main cable
- USB cable
- TP block
- Tool kit

@percotronics



www.percotronics.com